

Signature  
Design

**Tork Xpressnap®**  
**Stand Napkin Dispenser**

**Tork Xpressnap®**  
**Distributeur de serviettes sur pied**

**Tork Xpressnap®**  
**Steh- und Wandspender**



**N4**

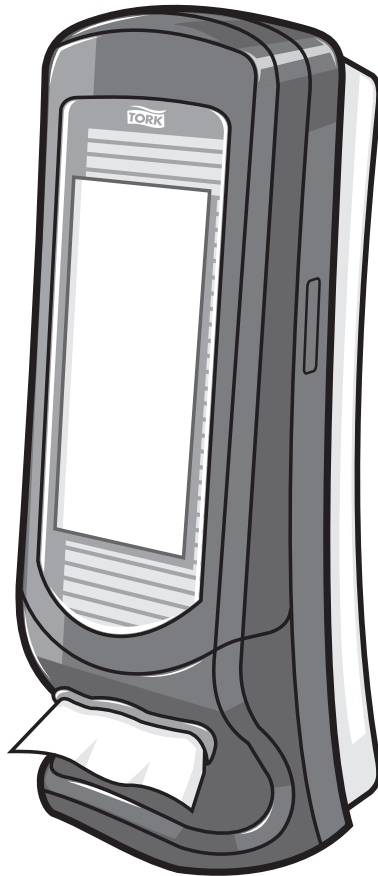

Tork Xpressnap® Stand Napkin Dispenser

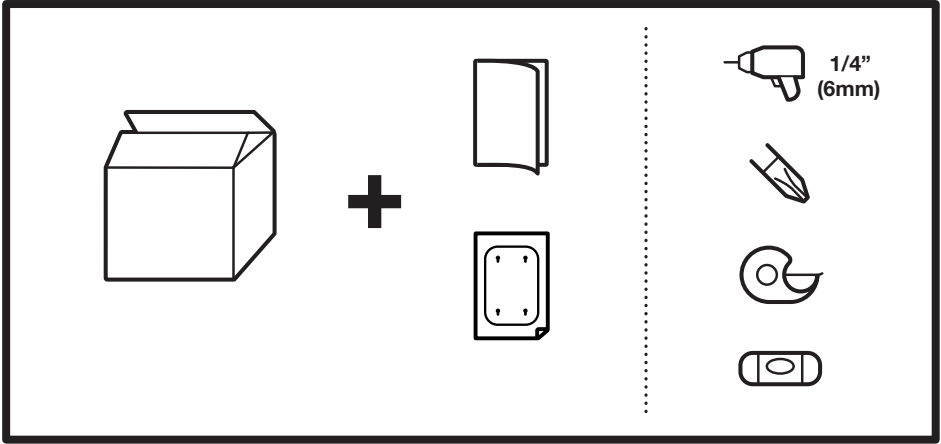

1

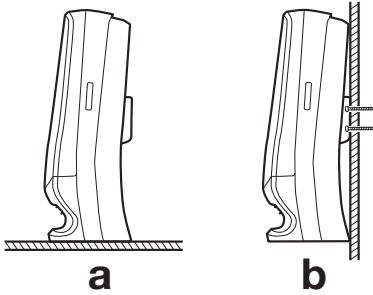

1b

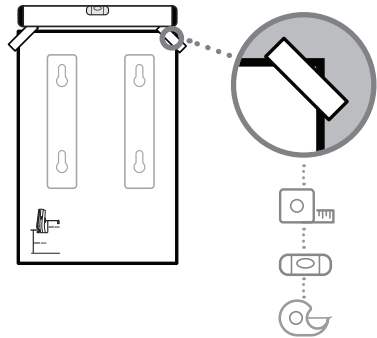

2b

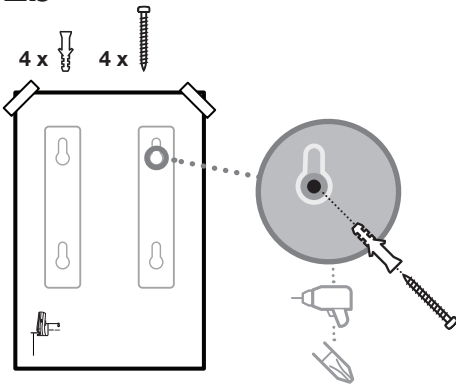

3b

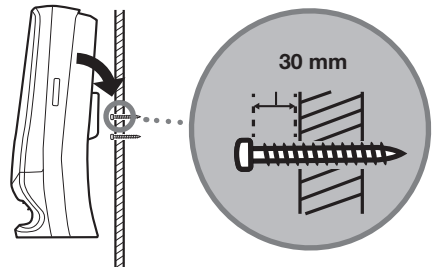

1

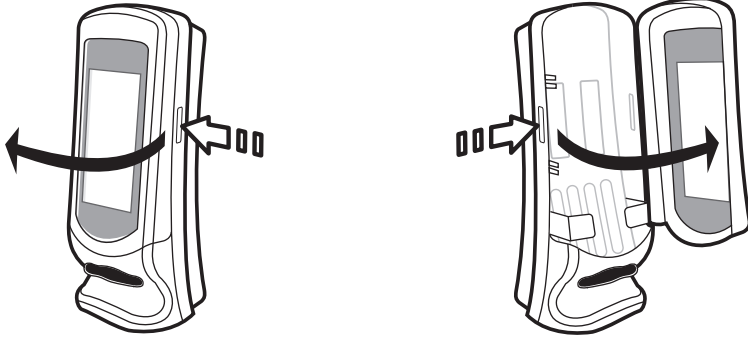

Door can be hinged to open from either side.

2

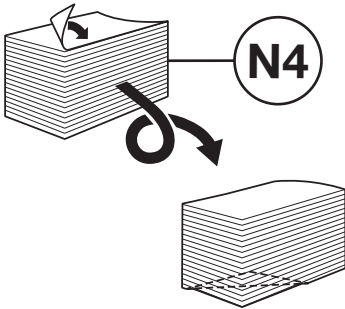

3

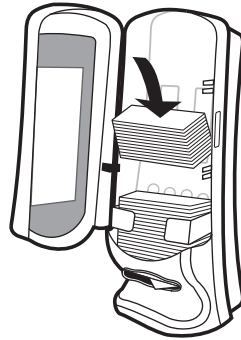

4

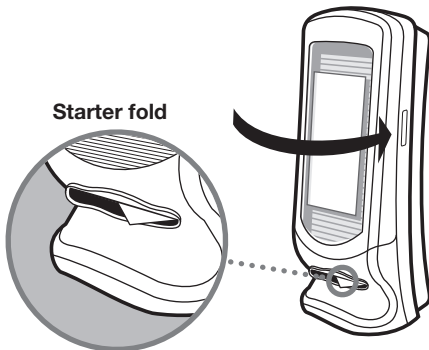

5

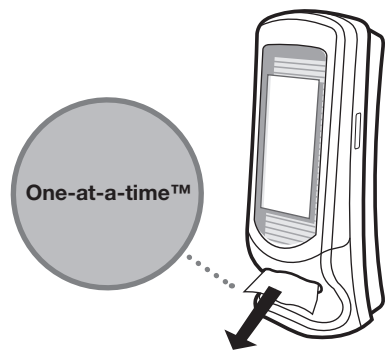

Tork Xpressnap® Stand Napkin Dispenser

1

AD-a-Glance™  
TEMPLATES | MODÈLES | VORLAGE  
[adaglance.torkglobal.com](http://adaglance.torkglobal.com)

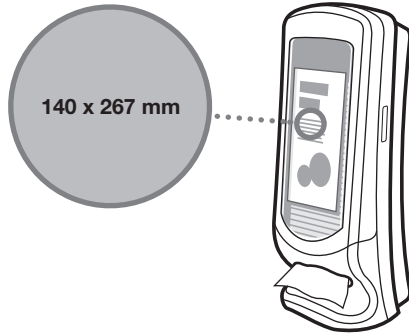

2

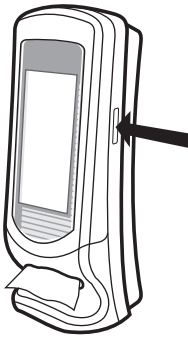

3

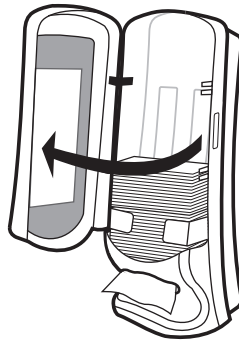

4

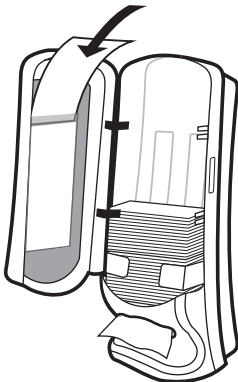

5

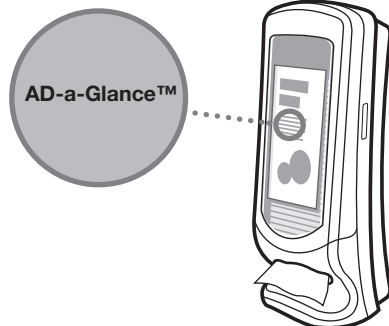

## EN Cleaning instructions

- Use mild cleaners. Wipe with cloth using soap and water. Do not use abrasives. Dispenser is not dishwasher safe.

## FR Instructions de nettoyage

- Utiliser des nettoyeurs non agressifs. Nettoyer avec chiffon, de l'eau et du savon. Ne pas utiliser d'agents abrasifs. Le distributeur n'est pas conçu pour au lave-vaisselle.

## DE Reinigungsanweisungen

- Milde Reinigungsmittel verwenden. Abwischen mit einem Tuch unter Verwendung von Wasser und Seife. Keine Scheuermittel verwenden. Spender ist nicht spülmaschinenfest.

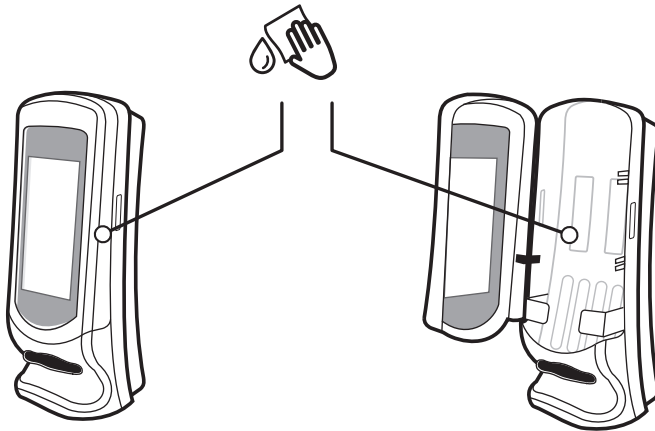

Manufactured by [Essity Hygiene and Health AB](#)  
[SE-405 03 Göteborg, Sweden](#)

[Visiting address: Mölndals Bro 2, Mölndal](#)  
[www.essity.com](#), [www.torkglobal.com](#)

Made in United States

Patents/Brevets/Patentes: [www.essity.com/patents](#)

Essity UK Limited  
Southfields Road, Dunstable,  
Bedfordshire, LU6, 3SEJ, UK